

COMPOSITE PIEZOELECTRIC MATERIALS FOR MEDICAL ULTRASONIC IMAGING TRANSDUCERS -- A REVIEW

Wallace Arden Smith

Philips Laboratories, North American Philips Corporation
Briarcliff Manor, New York 10510 USA

Abstract

This paper surveys published research on the use of composite piezoelectric materials to make the acoustic transducers used in medical ultrasonic imaging. For medical imaging transducers, attention has focused on the 1-3, PZT-rod/polymer composite structure. The piezoelectric plates used in such ultrasonic transducers consist of a polymer matrix which holds together parallel thin rods of piezoelectric ceramic oriented perpendicular to the faces of the plate. By varying the properties, proportions and spatial scales of the polymer and piezoceramic constituents a rich variety of material properties are achieved. Of particular interest for medical imaging transducers is the ability to engineer materials whose electromechanical coupling is higher than that of conventional materials and whose acoustic impedance is close to that of tissue. Besides these basic advantages in material parameters, composites have properties that facilitate meeting other technological requirements. Flexible composite piezoelectrics can be formed into complex curved shapes for steering and focusing the acoustic waves. Transducer arrays can be made from composites by patterning the electrode alone -- cutting the piezoelectric is not required.

1. Introduction

A variety of composite piezoelectric materials can be made by combining a piezoelectric ceramic with a passive polymer phase [1-7]. These new piezoelectrics greatly extend the range of material properties offered by the conventional piezoelectric ceramics and polymers. Moreover, by varying the composition within a given composite structure one can fine tune the material properties to specific device requirements.

Recently, composite piezoelectrics have found fruitful application in transducers for pulse-echo medical ultrasonic imaging [8, 12, 13, 16-18, 20, 21, 23-26]. An early survey [8] of the suitability of the various composite structures for pulse-echo ultrasonic applications identified the 1-3 composite geometry as the most promising. Subsequent studies of composites for medical ultrasonics have focused on this PZT-rod/polymer structure which is shown schematically in Figure 1. In making medical imaging transducers, metal electrodes are applied to the faces of these plates. When a voltage pulse is applied across this material it excites the thickness-mode oscillations in that plate in a band of frequencies near the fundamental thickness resonance of the plate. The resulting acoustic vibrations are projected into the soft tissues of the human body where they scatter off organ boundaries and off structures within those organs. Echoes returning to the transmitting transducer excite thickness oscillations in the piezoplate; this generates the electronic signal used to make the image. The same transducer acts as both transmitter and

receiver. By scanning the direction of the interrogating beam and properly interpreting the returning echoes, one builds a picture of the interior of the body which has substantial diagnostic value to physicians.

There are several requirements for the piezomaterial used in these transducers. First, for sensitive transducers, the piezoelectric must efficiently convert between electrical and mechanical energy; so the electromechanical coupling should be high. Second, the piezoelectric must be acoustically matched to tissue so that the acoustic waves in the transducer and tissue couple well both during transmission and reception; so the specific acoustic impedance should be close to that of tissue. Third, the materials electric impedance must be compatible with the driving and receiving electronics; so the dielectric constant must be reasonably large. Finally, good sensitivity requires low electrical and mechanical losses. Many other technological requirements (shapeability, thermal stability, structural strength, etc.) must be met but the primary requirements qua piezoelectric are: high electromechanical coupling ($k_t \rightarrow 1$), acoustic impedance close to that of tissue ($Z \rightarrow 1.5 \text{ Mrayls}$), reasonably large dielectric constant ($\epsilon^s \geq 100$) and low electrical ($\tan \delta \leq 0.10$) and mechanical ($Q_m \geq 10$) losses.

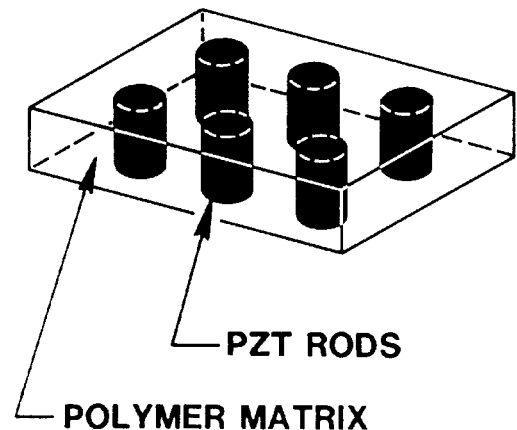

Figure 1. Schematic representation of 1-3, PZT-rod/polymer composites.

Conventional piezoelectric materials only partially meet these needs. Piezoelectric ceramics, such as lead zirconate-titanate, lead metaniobate and modified lead titanates, are the most popular choices for medical ultrasonic transducers. These ceramics offer high electromechanical coupling ($k_t \sim 0.4-0.5$), a wide selection of dielectric constants ($\epsilon^S \sim 100-2400$) and low electrical and mechanical losses ($\tan \delta \leq 0.02$, $Q_m \sim 10-1000$). Their major drawback is their high acoustic impedance ($Z \sim 20-30$ Mrayls). An elaborate acoustic matching layer technology has been developed to couple these ceramics to tissue; indeed, broadband, sensitive transducers can be made by this approach.

Piezoelectric polymers, such as polyvinylidene difluoride and its copolymer with trifluoroethylene, provide a contrasting set of material properties. Their low acoustic impedance ($Z \sim 4$ Mrayls) makes acoustic matching easy, but their low electromechanical coupling ($k_t \leq 0.3$) and high dielectric losses ($\tan \delta \sim 0.15$) seriously degrade the sensitivity; moreover, their low dielectric constant ($\epsilon^S \sim 10$) places severe demands on the transmitter and receiver electronics.

Composite piezoelectrics provide material properties superior to both the piezoceramics and piezopolymers. The coupling constant can be larger ($k_t \sim 0.6-0.75$) than those of the ceramics, while the acoustic impedance is much lower ($Z \leq 7.5$ Mrayls) - almost reaching the range of the piezopolymers. The composites also provide a wide range of dielectric constants ($\epsilon^S \sim 10-500$) and low dielectric and mechanical losses.

In addition to these improvements in basic material parameters, composite piezoelectrics can be designed to have other properties that are useful in making ultrasonic transducers. With an appropriate polymer, the composite can be easily formed into curved shapes for steering and focusing an acoustic beam. Composites can also be made with such low cross-talk between elements of an array defined by an electrode pattern that it is not necessary to isolate the array elements by cutting the piezoelectric.

This paper surveys published research not just from Philips Laboratories but also from Pennsylvania State University, Stanford University and Hitachi Central Research Laboratory on composite piezoelectric materials for ultrasonic transducers used in medical imaging. In this review I have highlighted those properties of composites that are most relevant to medical ultrasonics. Where possible, each point has been illustrated with a figure taken from the published literature. Selecting a particular figure or citing a particular reference is not to establish priority amongst the contributions, but rather to direct the reader to a source where the point is discussed in more detail.

2. Material Fabrication

A number of different ways to make rod composites have been described in the literature. Initial samples at Pennsylvania State University were made by first extruding and firing long rods of PZT. Many such rods were then aligned parallel to each other with a fixture and a polymer was cast to hold them together. Slicing the resulting assembly parallel to the rods produces samples such as are shown in Figure 2. The principal limitation of this fabrication method appears in making samples with fine lateral scales; producing and aligning a large number of fine ceramic rods is a daunting task. This limitation becomes serious as the rod size approaches 250 microns.

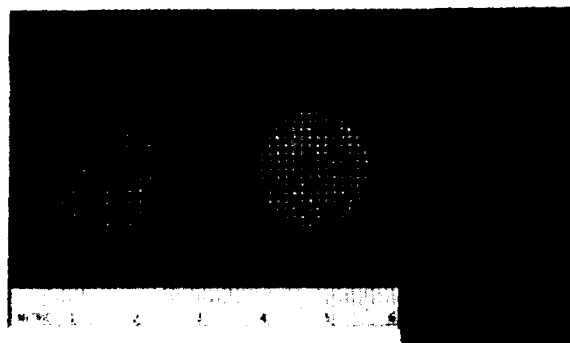

Figure 2. Composite disks fabricated by embedding extruded PZT rods in a polymer (After Gururaja et al. [19]).

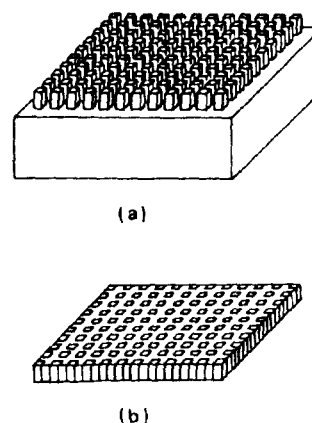

Figure 3. Dice-and-fill composite fabrication technique (After Takeuchi et al. [13]).

In another fabrication method the rods are made from a single block of fired PZT [4, 13, 17, 21]. An array of square pillars is formed by cutting deep grooves into a ceramic block; casting a polymer into these grooves produces the desired composite structure as illustrated in Figure 3. By this dicing-and-filling technique, composites are made containing tens of thousands of square rods whose cross section can be 50 micron by 50 micron [21] or even smaller.

A third technique based on lamination eliminates the casting of the passive polymer phase [25]. As illustrated in Figure 4, a block of material is first formed by laminating a piezoelectric and a passive material in alternating layers; that block is then cut into plates which are laminated with alternating layers of passive material to form the final composite structure. This approach allows incorporation of passive materials that are not readily cast and yields composites with long, thin rods.

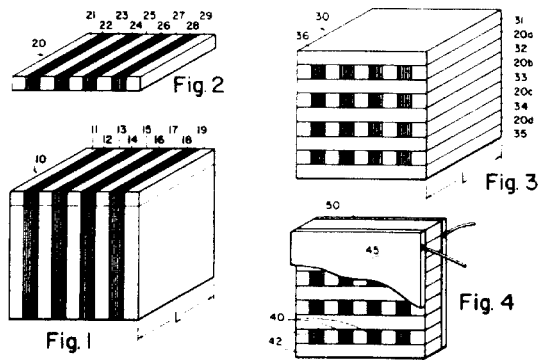

Figure 4. Laminate composite fabrication technique (After Zola [25]).

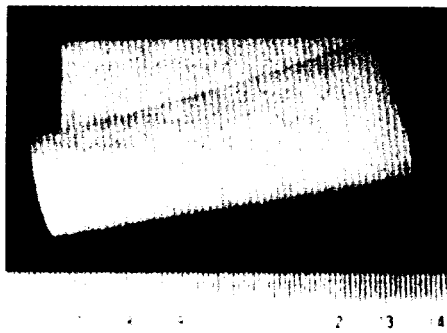

Figure 5. Flexible PZT/polyurethane 1-3 composite with 25% PZT (After Takeuchi et al. [13]).

In making these 1-3 composites for medical ultrasound applications, the piezoceramics have been basically a PZT formulation while choices for the passive phase have spanned a greater range. Using a soft polymer produces a very flexible piezoelectric material [13], as is shown in Figure 5. Somewhat stiffer polymers yield composites that can be formed into curved shapes, yet which possess enough strength to retain that shape once formed [21].

3. Dynamics and Composite Scale

In making ultrasonic transducers from these rod composites it is important to understand the high frequency dynamics of the material. Detailed experimental and theoretical studies of their dynamic behavior reveal a rich set of phenomena [9-12, 14, 15, 19, 22]. The complexity in the dynamics stems from the possibility of exciting standing wave resonances of Lamb waves in the periodic lattice of rods. Figure 6 shows resonances in the electrical impedance caused by the thickness mode resonance as well as the first two resonances of lateral running waves.

In medical ultrasonic transducers the piezoelectric plate is excited by a short pulse whose frequency is centered near the fundamental thickness mode oscillations in that plate. Only if these lateral stop-band resonances are at much higher frequencies will the fundamental thickness vibration be a uniform expansion and contraction of the plate as a whole. If these lateral resonances are not remote from the thickness frequency, they will introduce an additional loss mechanism and the plate oscillations will not be uniform across its face. Figure 7 shows a laser probe measurement of the displacement pattern across three composite plates excited at their respective thickness resonances; only in case (c) are the lateral modes sufficiently remote that the displacement pattern is substantially uniform across the face of the plate.

The frequency of these lateral stop-band resonances increases as the periodicity of the plate becomes finer, while the frequency of the thickness resonance depends only on the plate thickness. Thus by making the lateral spatial scale of the composite sufficiently fine compared with its thickness, one can reach a regime in which the composite behaves effectively as a homogeneous medium in the vicinity of its fundamental thickness-mode frequency.

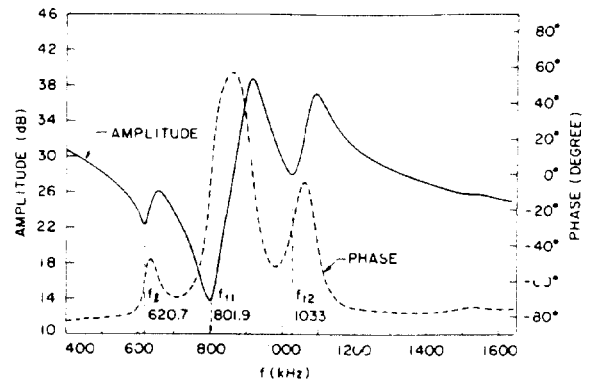

(a)

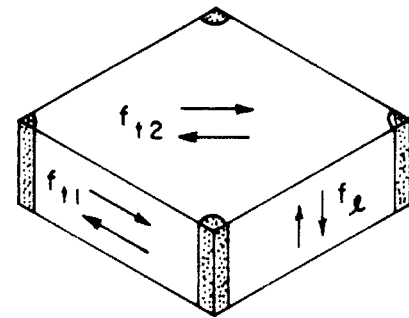

(b)

Figure 6. Resonance spectrum of a 2-D periodic composite plate resonator: (a) Typical measured impedance curve; (b) Corresponding standing wave patterns inside a unit cell of the 2-D lattice (After Auld and Wang [15]).

An alternate way to deal with the non-uniform displacement pattern caused by the periodic array of rods in the composite is to consider the grating lobes in the radiation pattern caused by this array [21]. When the composite pitch is sufficiently small compared with the wavelength of sound in the medium, the grating lobes are suppressed far below the main radiation lobe. The wavelength of sound radiated by the thickness mode resonance is, of course, proportional to the thickness of the composite plate. Thus, these considerations lead us to the same type of criterion: the periodicity of the composite structure must be sufficiently fine compared with the plate thickness. However, the quantitative details as to what constitutes "sufficiently fine" will differ.

4. Material Properties

If the lateral periodicity of the rods is sufficiently fine compared to the plate thickness we may treat the composite piezoelectric as a homogeneous medium with a set of "effective" material parameters. In a given sample, these parameters can be evaluated readily from the measured electrical impedance over a band of frequencies near the thickness mode resonance in that sample. Figure 8 shows the measured impedance and the theoretical fit that determines the material parameters, $k_t = 0.60$, $Z = 7.5 \text{ Mrayl}$, $\epsilon^S = 200$, and $v^D = 3400 \text{ m/sec}$, in one particular composite disk.

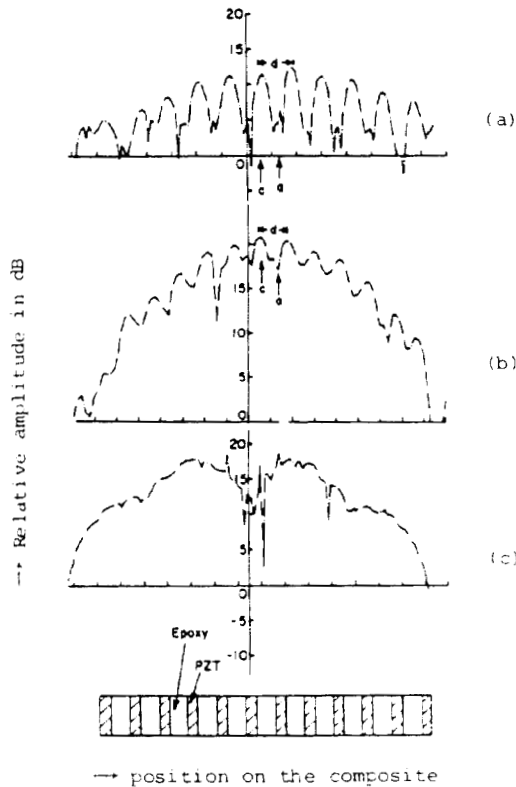

Figure 7. Laser probe measurements of the relative amplitude of the acoustic vibration at the thickness mode resonance: (a) and (b) composite plates with lateral stop-band resonances near the thickness mode resonance; (c) composite plate with lateral stop-band resonances far above the thickness mode resonance (After Gururaja et al. [14]).

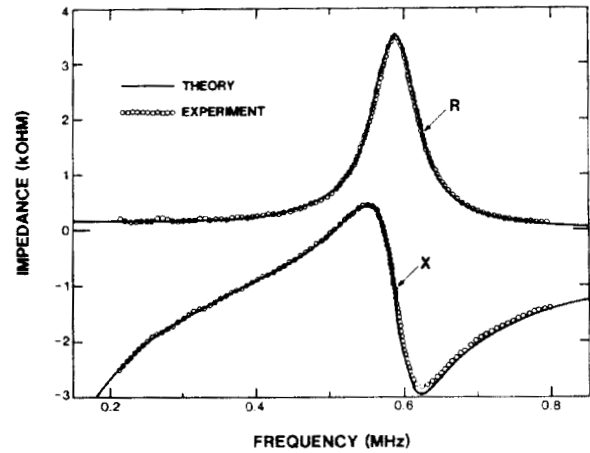

Figure 8. Real and imaginary parts of the electric impedance of a composite disk (with one face in water) measured near its thickness resonance plus the fitted curves which determine the material parameters, k_t , Z , ϵ^S , and v^D (After Smith et al. [17]).

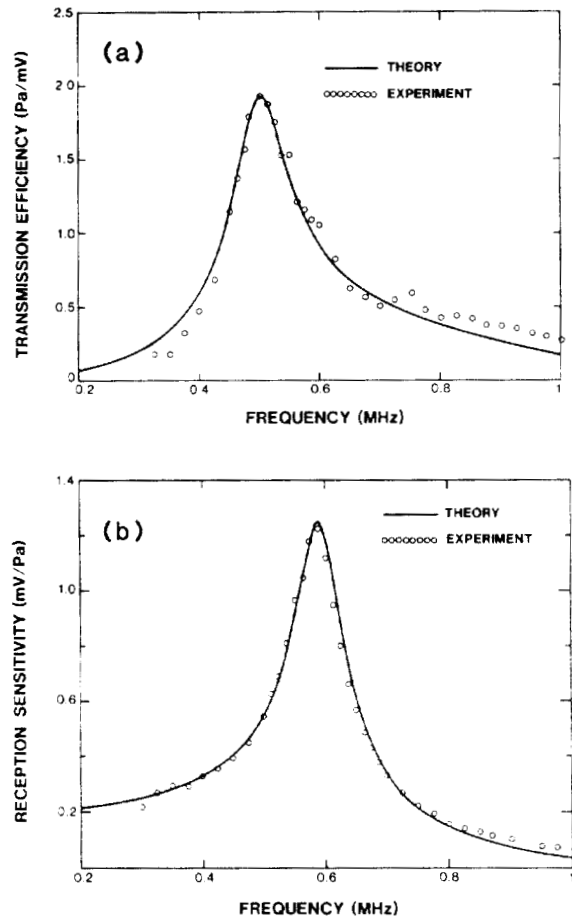

Figure 9. Absolute transmission efficiency and absolute reception sensitivity measured on a composite disk along with theoretical fits. The material parameters used in these fits agree well with those determined from the resonance in the electrical impedance (After Smith et al. [17]).

These data are sufficient information to predict the acoustic performance of a transducer made from this material. However, since any resonance in the electrical impedance can be analyzed to produce a set of material parameters, it is important to confirm that the measured parameters do indeed accurately describe the acoustic performance of the material [17]. Figure 9 illustrates the desired confirmation; the absolute acoustic transmission efficiency and absolute reception sensitivity measured on this same composite disk are fit with the theoretical expressions using material parameters that agree well with those measured from the electrical impedance resonance. Thus we may confidently project the performance of composite transducers from the effective material parameters using conventional transducer design codes.

The material parameters of the composites depend, of course, on the properties of the constituent piezoceramic and polymer and their relative proportions. The detailed structure of the composite is not relevant so long as we remain in the limit where composites may be treated as a homogeneous material. In this case, a simple

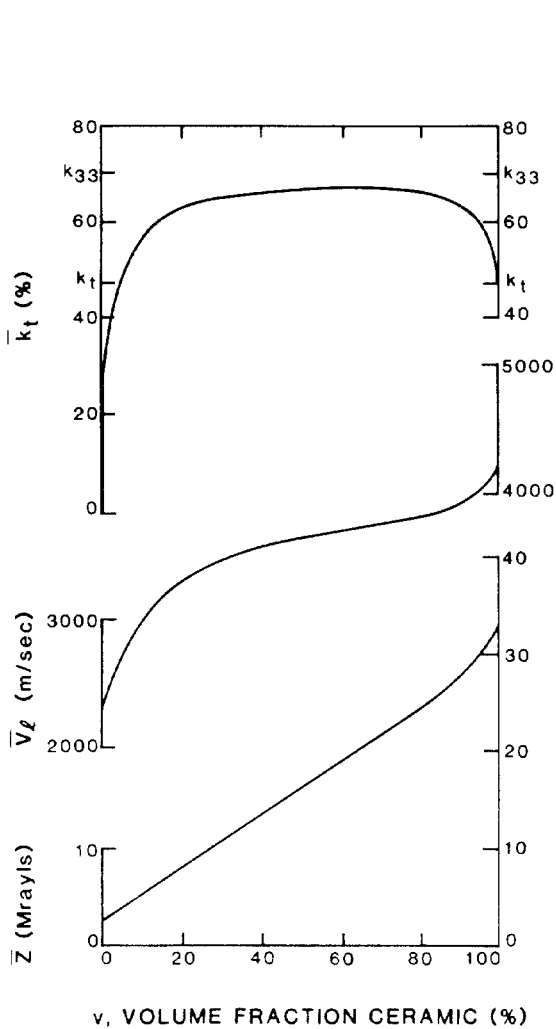

Figure 10. Variation of transducer parameters of a composite with volume fraction of piezoceramic (After Smith et al. [23]).

physical model has been developed to calculate the composite properties in terms of the properties and proportions of the constituents [23]. Figure 10 illustrates how the composite parameters relevant to transducer performance vary with volume fraction of piezoceramic for a given ceramic and polymer. This figure shows the trade-off that must be made between lowering the acoustic impedance and retaining a high coupling as the volume fraction decreases. Nevertheless, there is clearly a broad range of proportions over which the composites' coupling coefficient is higher and its acoustic impedance lower than those of the piezoceramic component.

If one does not restrict oneself to spatial scales within the domain of this simple theory, the composite material properties can be readily determined experimentally [13, 26]. Figure 11 illustrates the variation of the electromechanical coupling and dielectric constant with volume fraction of PZT and with the aspect ratio of the PZT pillars in the composite.

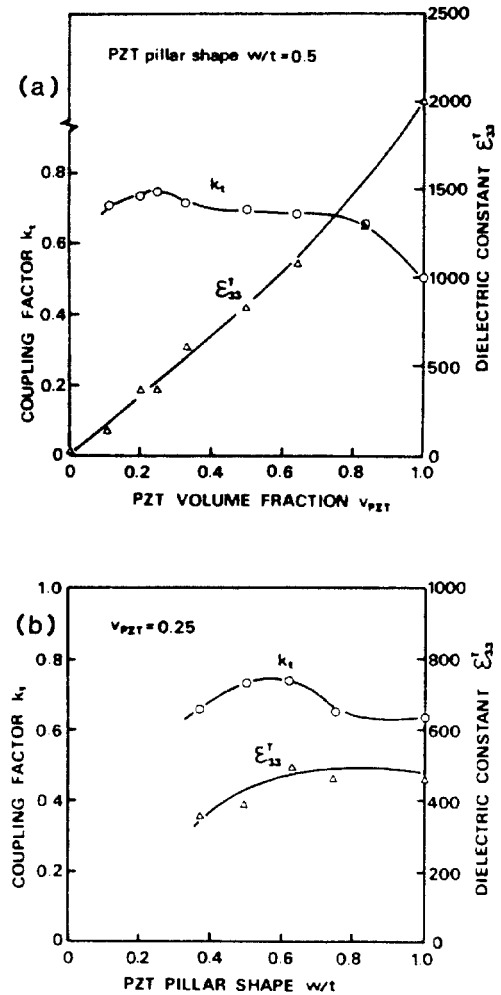

Figure 11. Electromechanical coupling constant, k_t , and dielectric constant, ϵ_{33}^T , as a function of: (a) the PZT volume fraction and (b) the width to thickness ratio, w/t , of the PZT pillars (After Takeuchi et al. [13]).

5. Transducer Performance

The high electromechanical coupling and low acoustic impedance of the composites can be directly translated into a compact impulse response and a high sensitivity in a pulse-echo transducer. We see in Figure 12 the short echoes (-20dB ringdown of 3 periods and -40 dB ringdown of 7.2 periods) and the high sensitivity (minimum insertion loss 3.8dB) over a broad bandwidth (50% at 6dB) that were achieved in an air-backed transducer with a single acoustic matching layer. Figure 13 illustrates the compact impulse response (-20dB pulse length of 3 periods) and the excellent beam profile obtained in a 7.5 MHz concave disk transducer.

Array transducers have also been produced from composites. The arrays show the same good sensitivity and compact echoes as single element transducers; moreover, they exhibit low cross-talk between elements in the array. As Figure 14 illustrates, the array elements need only be defined by the electrode pattern in order to achieve the desired single element radiation pattern; the piezoelectric need not be cut to provide acoustic isolation between the elements.

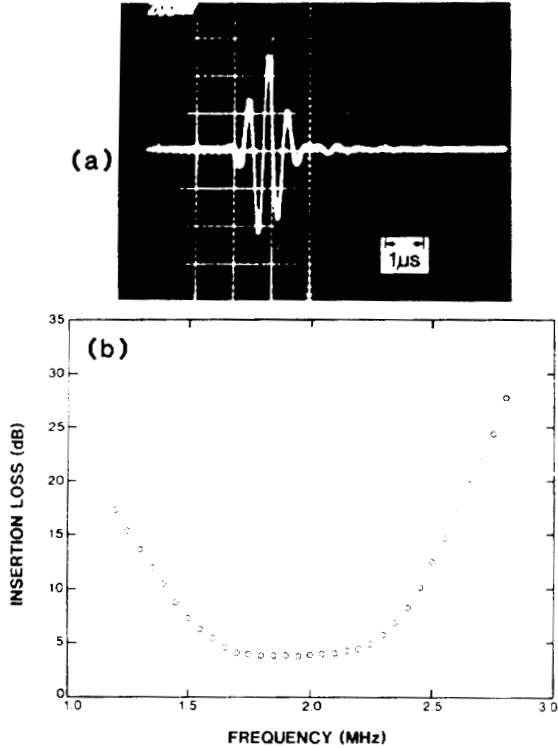

Figure 12. (a) Time-domain impulse response and (b) two-way insertion loss measured on a 2MHz composite disk transducer (After Shaulov et al. [18]).

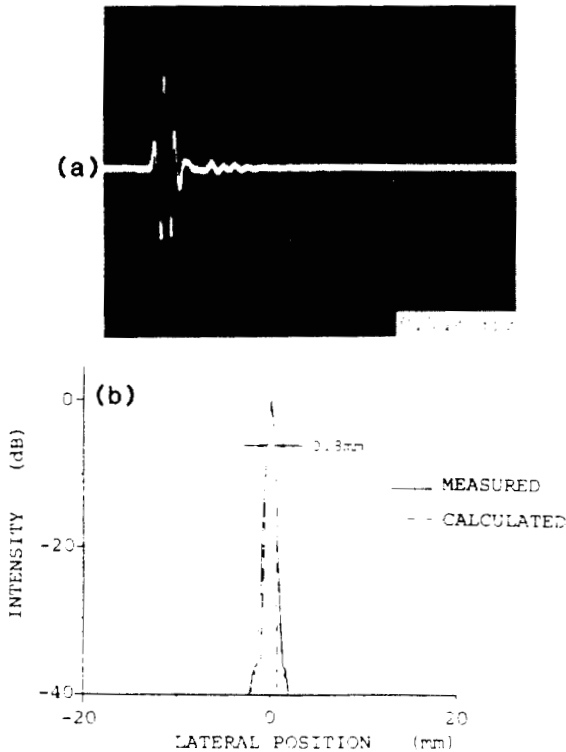

Figure 13. (a) Time-domain impulse response and (b) beam profile of a 7.5 MHz concave disk transducer (After Nakaya et al. [21]).

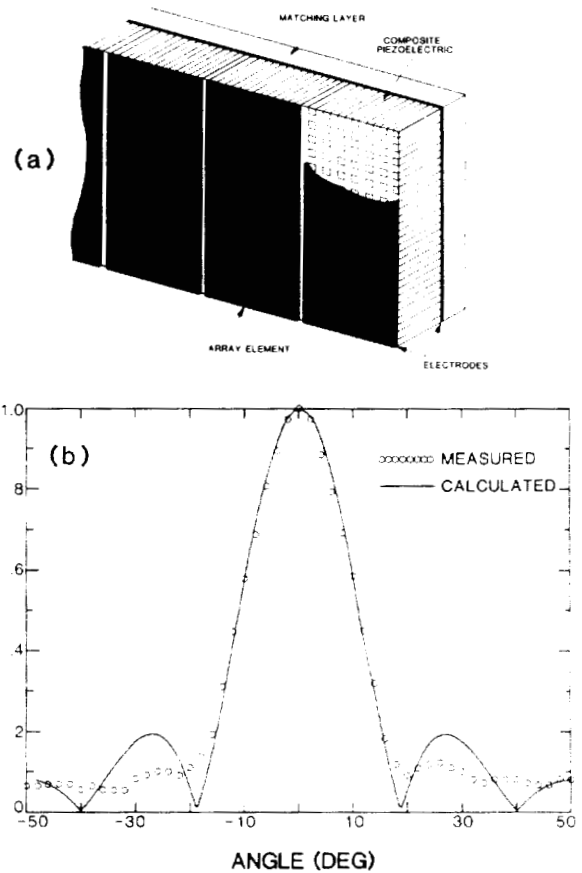

Figure 14. (a) Schematic representation of a composite linear array with elements defined by the electrode pattern alone and (b) the CW radiation pattern from a single element of such an array compared with the radiation pattern calculated for an isolated element of the same width (After Shaulov et al. [24]).

The definitive test of these composite transducers is, of course, in the acoustic images they produce. Figure 15 shows the good quality image of a sponge phantom taken with a 5 MHz curved linear array.

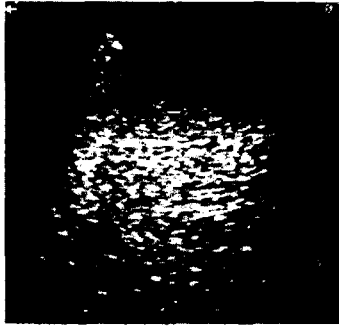

Figure 15. Ultrasonic image of a sponge phantom taken with a 5 MHz convex linear array (After Nakaya et al. [21]).

6. Conclusions

The literature surveyed here shows that PZT-rod/polymer composite piezoelectrics have properties that offer a number of advantages for use in medical ultrasonic imaging transducers. Their electromechanical coupling constant is higher than that of conventional piezoelectric ceramics while their acoustic impedance is much closer to that of tissue; composites can yield broadband, sensitive transducers. Cross-talk is low between array elements defined by electrode patterns alone; arrays can be made without cutting the piezoelectric to isolate array elements. Composites can be quite flexible; they can be formed into curved shapes for beam focusing and steering.

We can thus expect that composite piezoelectrics will improve the performance of conventional medical ultrasonic imaging transducers and, in addition, will make possible the realization of novel transducer designs.

7. Acknowledgments

In preparing this review I have drawn upon numerous colleagues for insights both into the properties of composite materials and into the requirements of medical ultrasonic imaging transducers. Let me record here my debt to: Drs. A. Shaulov and B. Singer of Philips Laboratories, for insights into all aspects of this subject; Drs. P. J. 't Hoen, S. O. Ishrak and E. J. Pisa of Philips Ultrasound, Inc., for clarifying the problems and opportunities in medical ultrasonic imaging; Prof. L. E. Cross, Dr. T. R. Gururaja and Prof. R. E. Newnham of the Pennsylvania State University, for illuminating the properties of composite materials; Prof. B. A. Auld of Stanford University, for making clear the dynamics of composite materials; and Dr. H. Takeuchi of Hitachi Central Research Laboratory for elucidating the contributions of the Hitachi research team to this subject.

8. References

1. R. E. Newnham, D. P. Skinner and L. E. Cross, "Connectivity and Piezoelectric-Pyroelectric Composites," *Materials Research Bulletin* 13, 525-536 (1978).
2. D. P. Skinner, R. E. Newnham and L. E. Cross, "Flexible Composite Transducers," *Materials Research Bulletin* 13, 599-607 (1978).
3. R. E. Newnham, L. J. Bowen, K. A. Klicker and L. E. Cross, "Composite Piezoelectric Transducers," *Materials in Engineering* 2, 93-106 (1980).
4. H. P. Savakas, K. A. Klicker and R. E. Newnham, "PZT-Epoxy Piezoelectric Transducers: A Simplified Fabrication Procedure," *Materials Research Bulletin* 16, 677-680 (1981).
5. A. Safari, R. E. Newnham, L. E. Cross and W. A. Schulze, "Perforated PZT-Polymer Composites for Piezoelectric Transducer Applications," *Ferroelectrics* 41, 197-205 (1982).
6. R. E. Newnham, A. Safari, G. Sa-gong and J. Giniewicz, "Flexible Composite Piezoelectric Sensors," *Proceedings of the 1984 IEEE Ultrasonics Symposium* 501-506.
7. R. E. Newnham, A. Safari, J. Giniewicz and B. H. Fox, "Composite Piezoelectric Sensors," *Ferroelectrics* 60, 15-21 (1984).
8. T. R. Gururaja, W. A. Schulze, T. R. Shrout, A. Safari, L. Webster and L. E. Cross, "High Frequency Applications of PZT/Polymer Composite Materials," *Ferroelectrics* 39, 1245-1248 (1981).
9. T. R. Gururaja, W. A. Schulze, L. E. Cross, B. A. Auld, Y. A. Shui and Y. Wang, "Resonant Modes of Vibration in Piezoelectric PZT-Polymer Composites with Two Dimensional Periodicity," *Ferroelectrics* 54, 183-186 (1984).
10. B. A. Auld, Y. A. Shui and Y. Wang, "Elastic Wave Propagation in Three-Dimensional Periodic Composite Materials," *Journal de Physique* 45, 159-163 (1984).
11. B. A. Auld, H. A. Kunkel, Y. A. Shui and Y. Wang, "Dynamic Behavior of Periodic Piezoelectric Composites," *Proceedings of the 1983 IEEE Ultrasonics Symposium* 554-558.
12. T. R. Gururaja, "Piezoelectric Composite Materials for Ultrasonic Transducer Applications," Ph. D. Thesis, The Pennsylvania State University, May, 1984.
13. H. Takeuchi, C. Nakaya and K. Katakura, "Medical Ultrasonic Probe Using PZT/Polymer Composite," *Proceedings of the 1984 IEEE Ultrasonics Symposium* 507-510.
14. T. R. Gururaja, W. A. Schulze, L. E. Cross, R. E. Newnham, B. A. Auld and J. Wang, "Resonant Modes in Piezoelectric PZT Rod-Polymer Composite Materials," *Proceedings of the 1984 IEEE Ultrasonics Symposium* 523-527.
15. B. A. Auld and Y. Wang, "Acoustic Wave Vibrations in Periodic Composite Plates," *Proceedings of the 1984 IEEE Ultrasonics Symposium* 528-532.
16. T. R. Gururaja, W. A. Schulze, L. E. Cross and R. E. Newnham, "Ultrasonic Properties of Piezoelectric PZT Rod-Polymer Composites," *Proceedings of the 1984 IEEE Ultrasonics Symposium* 533-538.

17. W. A. Smith, A. A. Shaulov and B. M. Singer, "Properties of Composite Piezoelectric Materials for Ultrasonic Transducers," Proceedings of the 1984 IEEE Ultrasonics Symposium 539-544.
18. A. A. Shaulov, W. A. Smith and B. M. Singer, "Performance of Ultrasonic Transducers Made from Composite Piezoelectric Materials," Proceedings of the 1984 IEEE Ultrasonics Symposium 545-548.
19. T. R. Gururaja, W. A. Schulze, L. E. Cross, R. E. Newnham, B. A. Auld and Y. J. Wang, "Piezoelectric Composite Materials for Ultrasonic Transducer Applications. Part I: Resonant Modes of Vibration of PZT Rod-Polymer Composites," IEEE Transactions on Sonics and Ultrasonics SU-32, 481-498 (1985).
20. T. R. Gururaja, W. A. Schulze, L. E. Cross and R. E. Newnham, "Piezoelectric Composite Materials for Ultrasonic Transducer Applications. Part II: Evaluation of Ultrasonic Medical Applications," IEEE Transactions on Sonics and Ultrasonics SU-32, 499-513 (1985).
21. C. Nakaya, H. Takeuchi, K. Katakura and A. Sakamoto, "Ultrasonic Probe Using Composite Piezoelectric Materials," Proceedings of the 1985 IEEE Ultrasonics Symposium 634-636.
22. Y. Wang and B. A. Auld, "Acoustic Wave Propagation in One-Dimensional Periodic Composites," Proceedings of the 1985 IEEE Ultrasonics Symposium 637-641.
23. W. A. Smith, A. Shaulov and B. A. Auld, "Tailoring the Properties of Composite Piezoelectric Materials for Medical Ultrasonic Transducers," Proceedings of the 1985 IEEE Ultrasonics Symposium 642-647.
24. A. Shaulov and W. A. Smith, "Ultrasonic Transducer Arrays Made from Composite Piezoelectric Materials," Proceedings of the 1985 IEEE Ultrasonics Symposium 648-651.
25. J. Zola, "Transducer Comprising Composite Electrical Materials," U.S. Patent 4,572,981, Feb 25, 1986.
26. H. Takeuchi and C. Nakaya, "PZT/Polymer Composites for Medical Ultrasonic Probes," Ferroelectrics 68, 53-62 (1986).